

375 Diameter Concrete Pipe

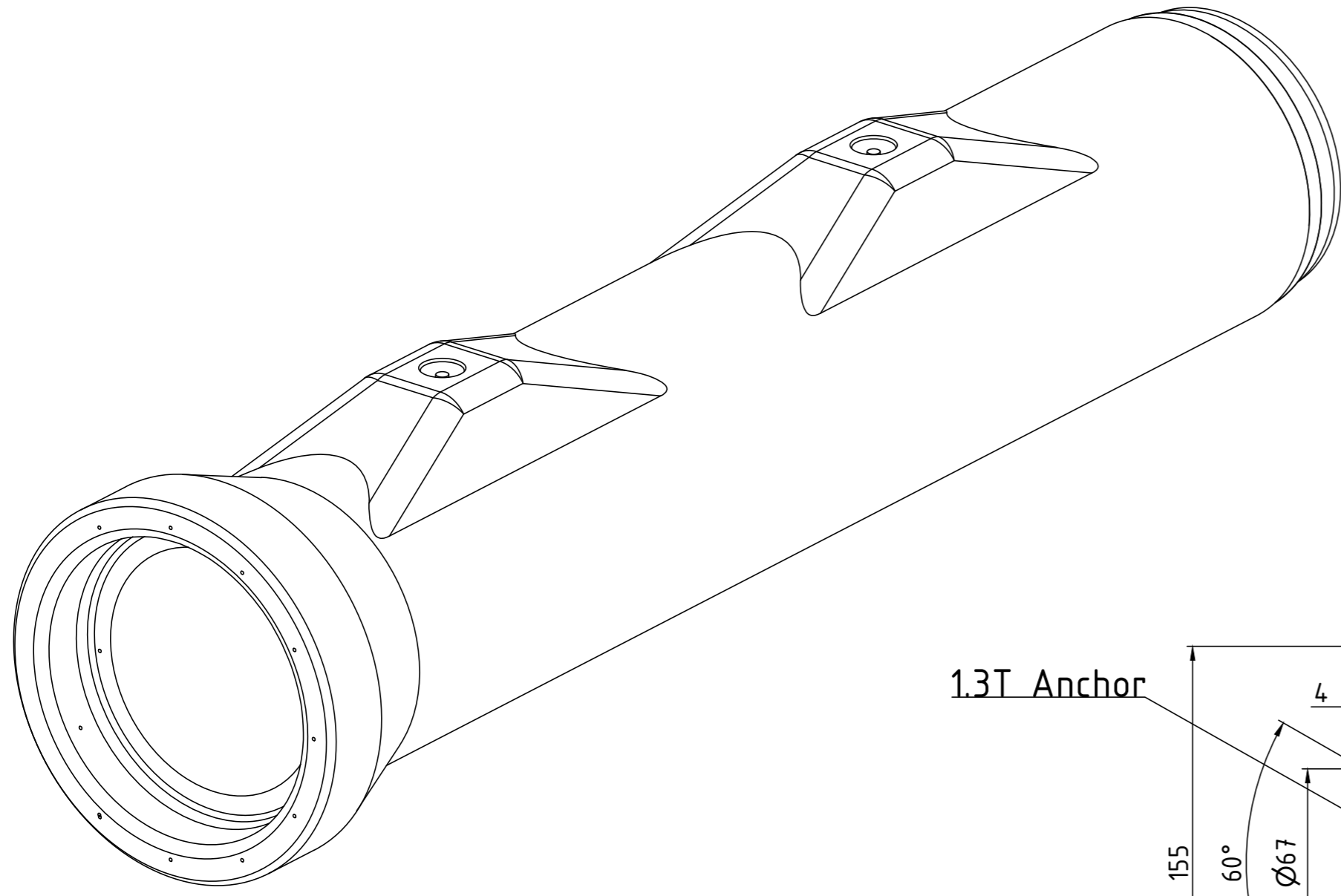

3D View

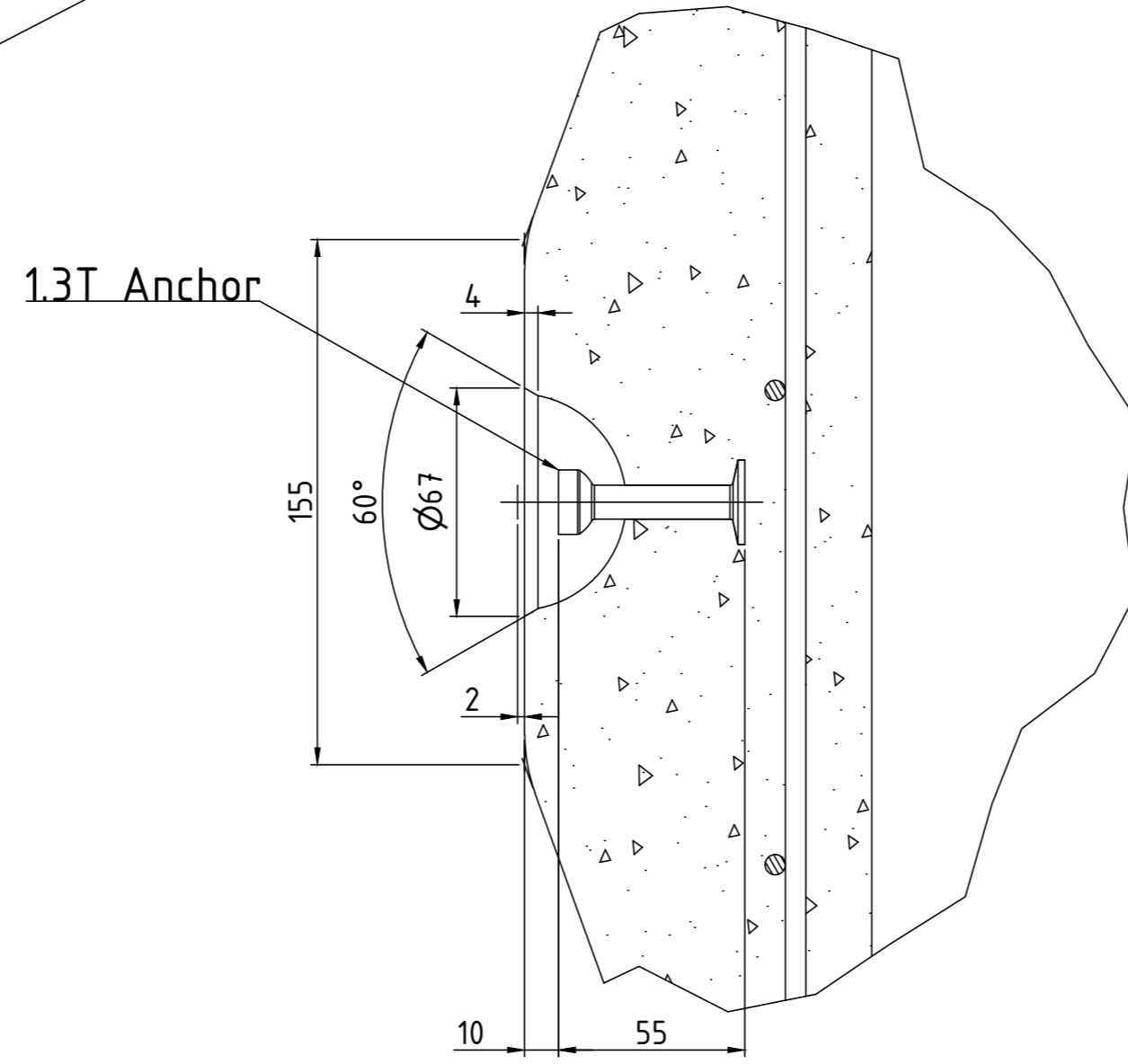

Detail B

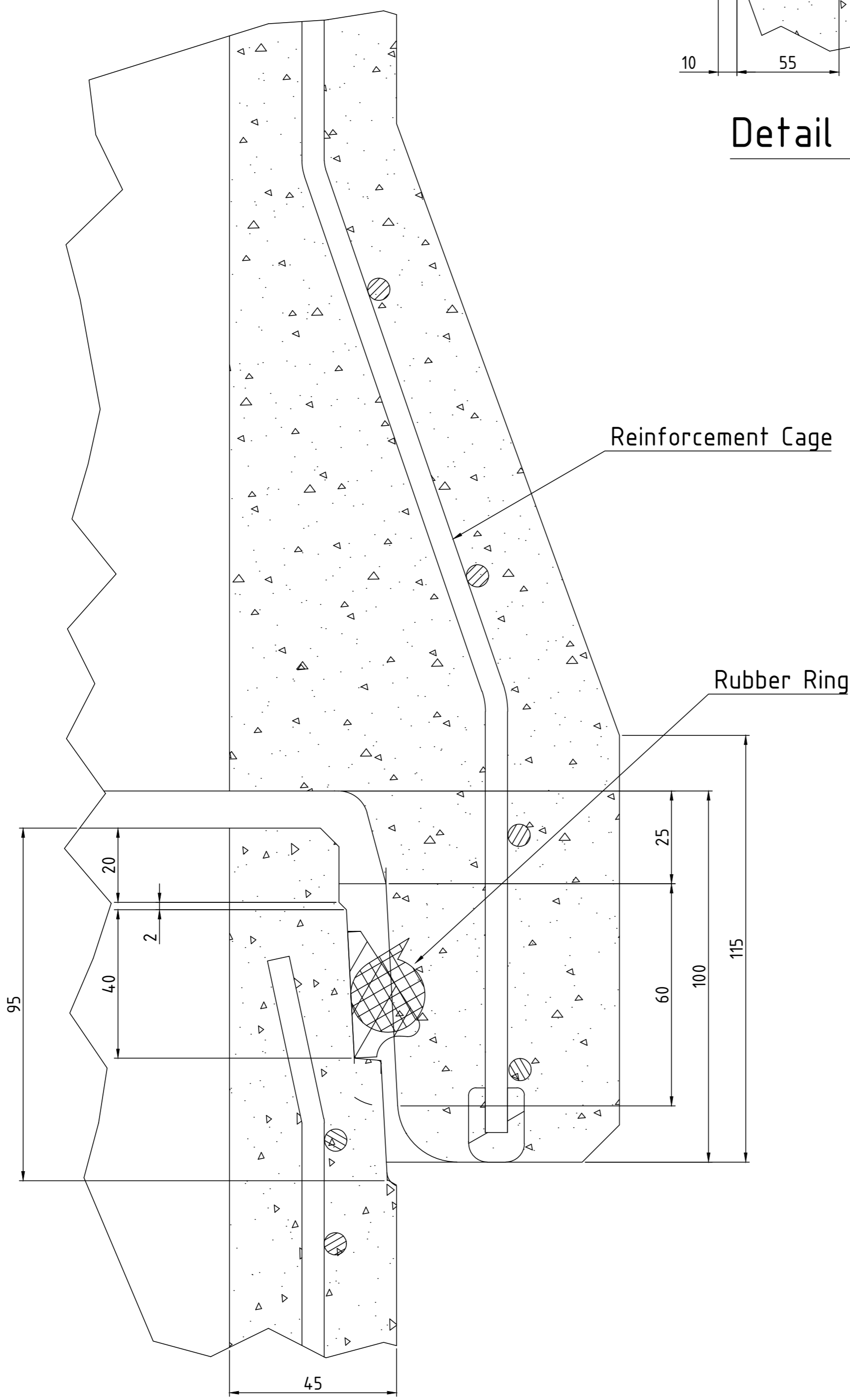

Pipe Joining Detail

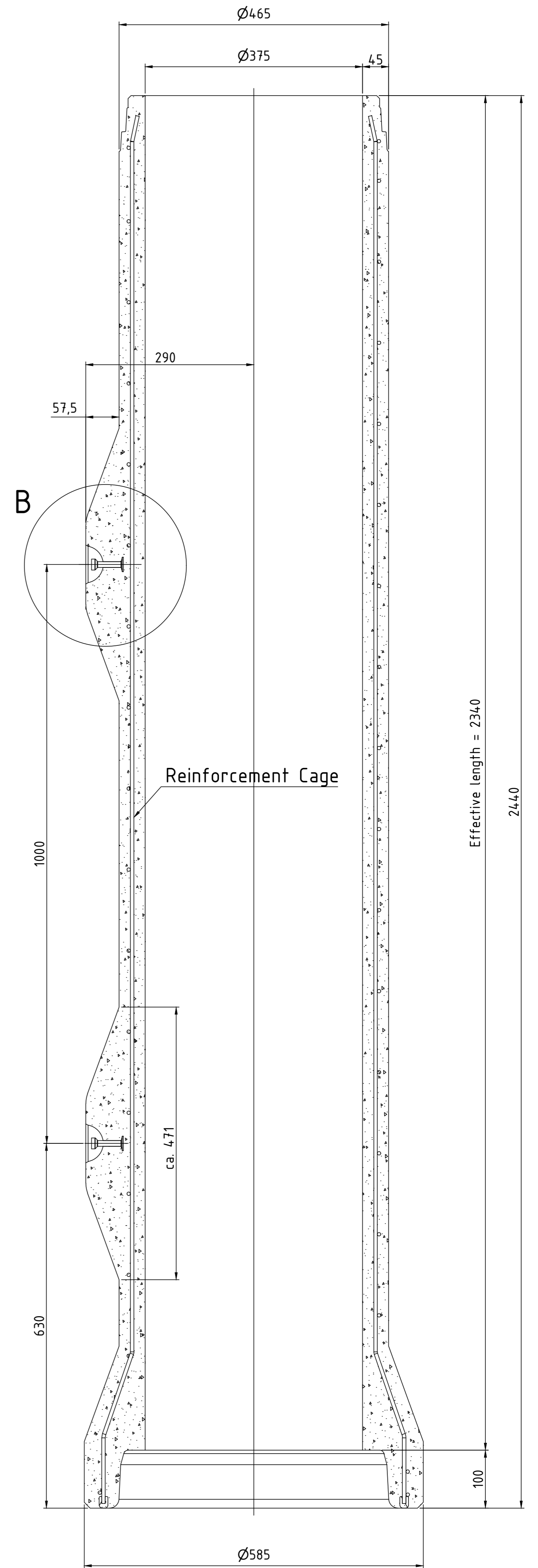

Section A-A

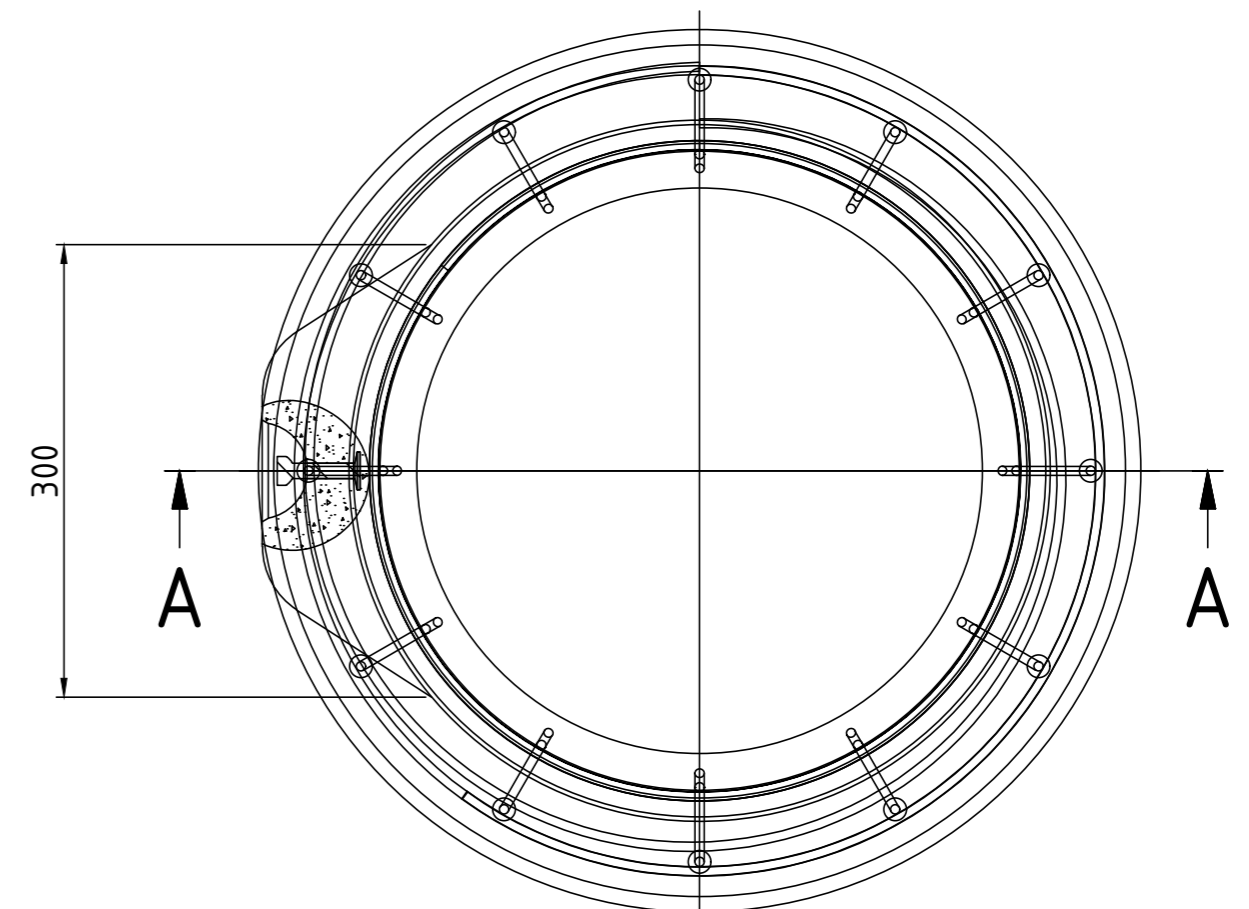

Plan View

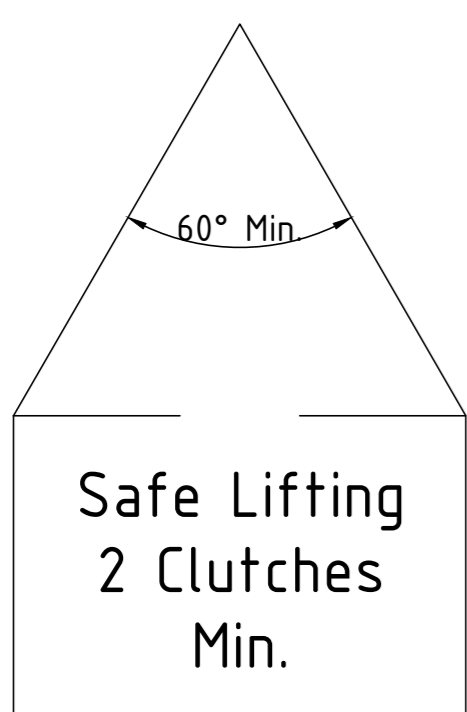

Safe Lifting Detail

LINKS

Stormwater Photographs

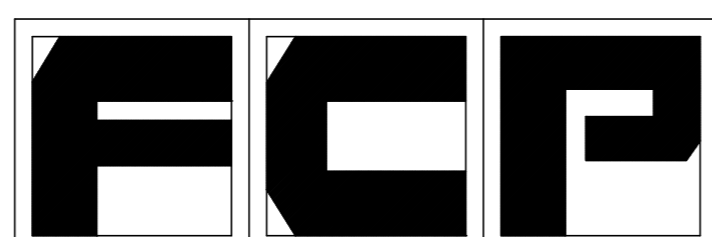

Frankston Concrete Products

9 Colemans Road
Dandenong South
VICTORIA 3175

Tel.(03)9786 3111 Fax.(03)9786 3208
web site - www.frankstonconcrete.com.au
email - sales@frankstonconcrete.com.au

DRAWN	M.D.S.
CHECKED	
APPROVED	N.Z.
SKU	PIPE375