

1200 x 750 Side Entry Frame & Insert

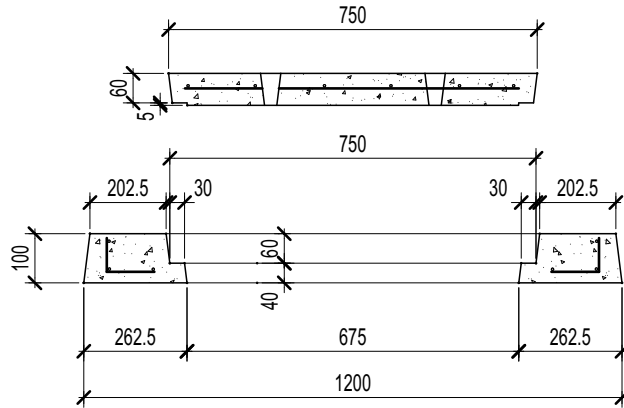

SECTION A-A

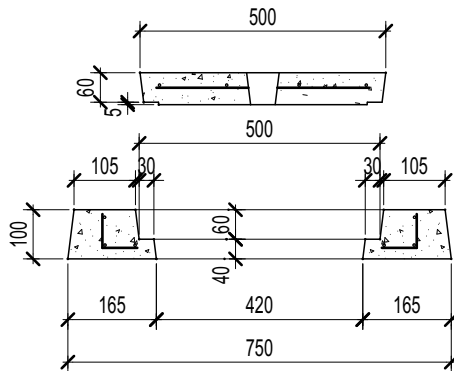

SECTION B-B

CONCRETE 40Mpa
 REINFORCEMENT
 SURROUNDS - N12
 INSERTS - F72
 LIFTERS 2x1.3ton

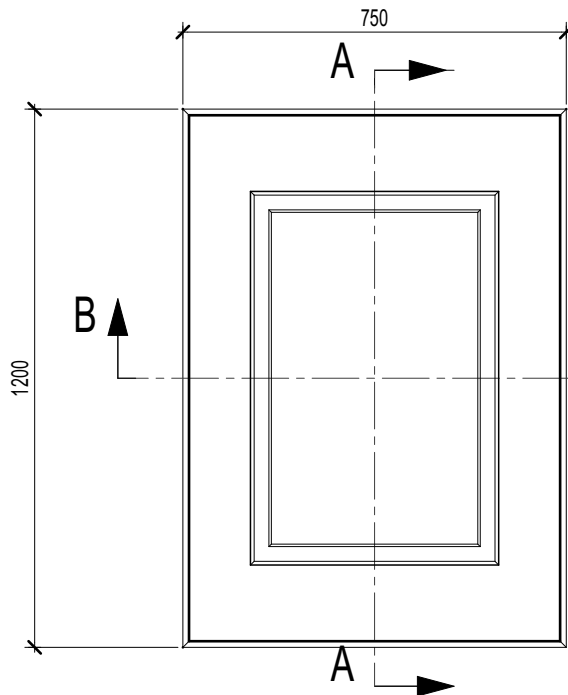

PLAN - SURROUND

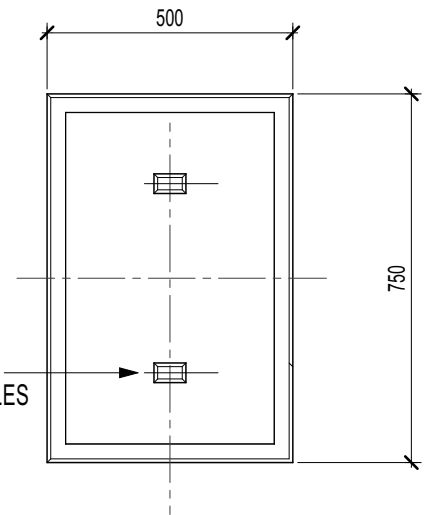

PLAN - INSERT

WEIGHT :-
 SURROUND 178 kg
 INSERT 58 kg